

<b>TOMMERUP VINDUET</b> <sup>A/S</sup>  Ellehaven 2-9 Tommerup Tel: 63 76 61 10 Fax: 63 76 61 11 Email: info@tommerupvinduet.dk	Dato:	16-01-04
	Mål:	1:1
Udadgående vindue	Udarb.:	M.Rabjerg
Lodret snit i bundkarm (fast)	Godk.:	
Snit V 9-not	Filnavn:	V9s-n

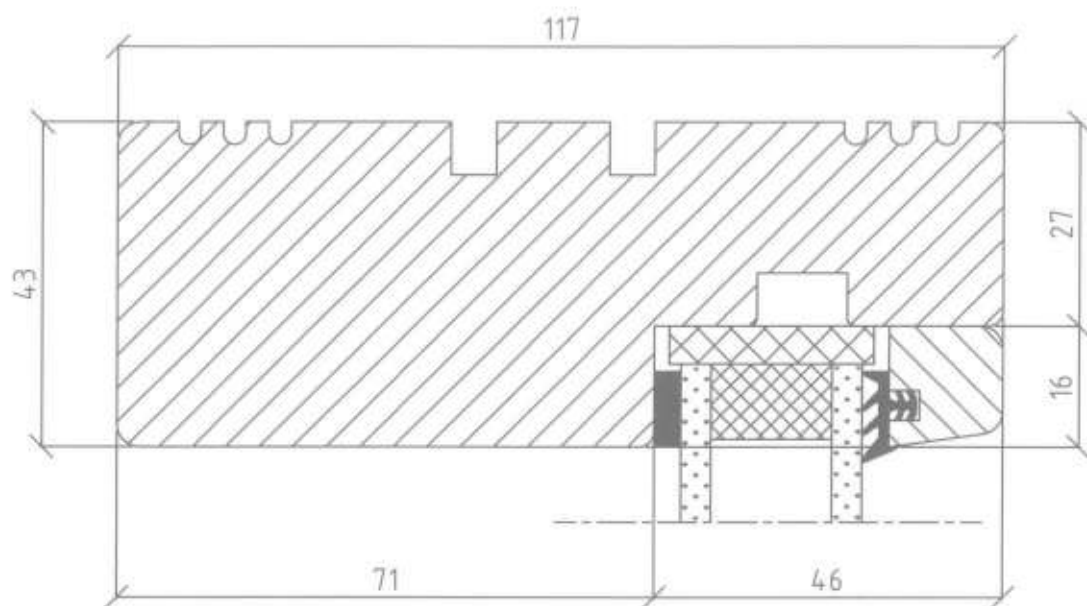

<b>TOMMERUP VINDUET A/S</b>  Ellehaven 2-9 Tommerup Tel: 63 76 61 10 Fax: 63 76 61 11 Email: info@tommerupvinduet.dk	Dato:	20-09-05
	Mål:	1:1
Udadgående vindue	Udarb.:	M.Rabjerg
Lodret snit i overkarm (fast)	Godk.:	
Snit V 7	Filnavn:	V7s

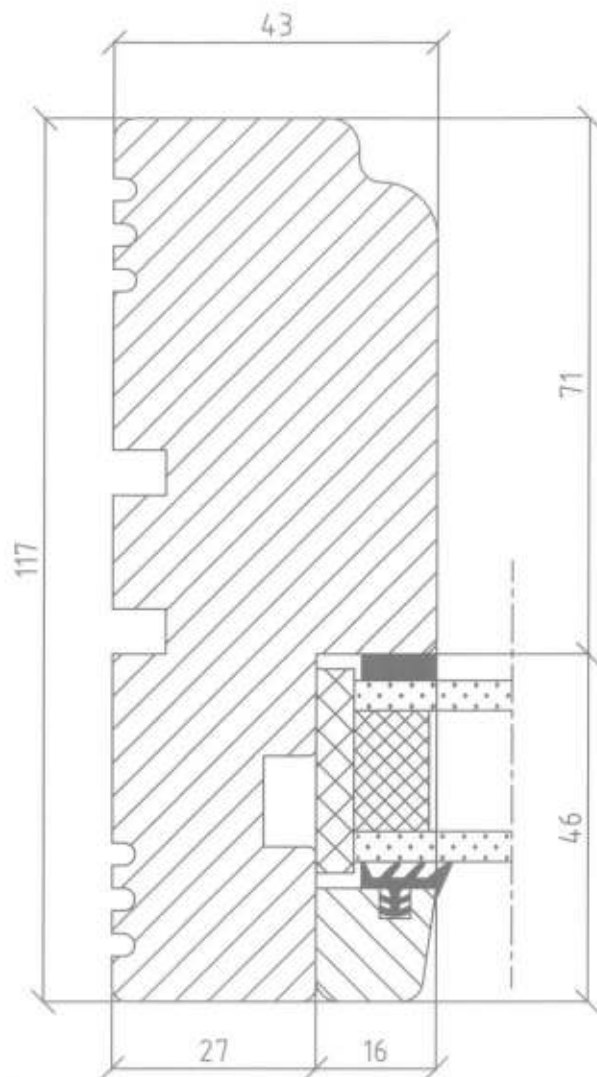

<b>TOMMERUP VINDUET A/S</b> <small>Ellehaven 2-9 Tommerup Tel: 63 76 61 10 Fax: 63 76 61 11 Email: info@tommerupvinduet.dk</small>		Dato:	16-01-04
		Mål:	1:1
Udadgående vindue		Udarb.:	M.Rabjerg
Vandret snit i sidekarm (fast)		Godk.:	
Snit V 8		Filnavn:	V8s

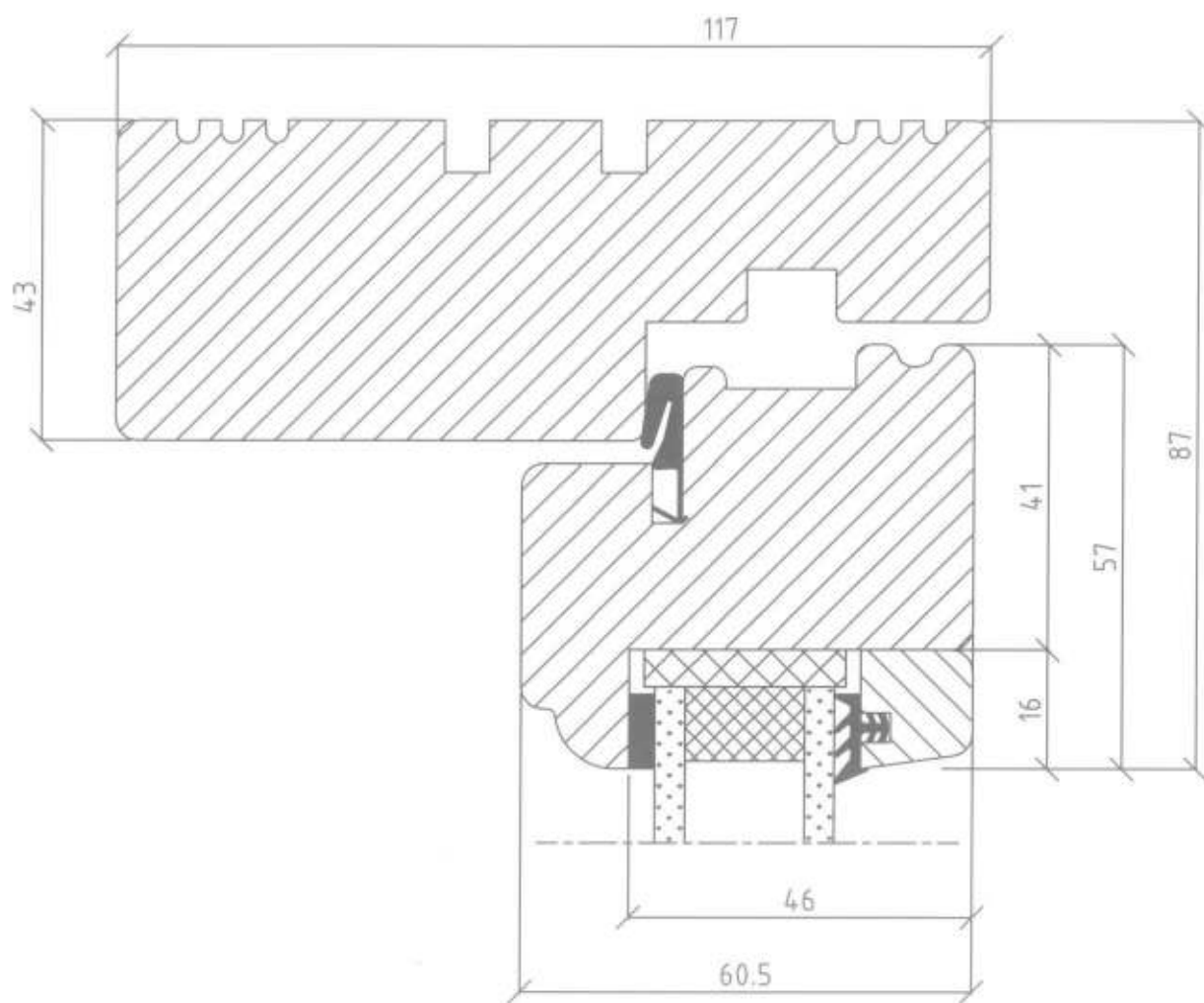

<b>TOMMERUP VINDUET A/S</b>  Ellehaven 2-9 Tommerup Tel: 63 76 61 10 Fax: 63 76 61 11 Email: info@tommerupvinduet.dk	Dato:	20-09-05
	Mål:	1:1
Udadgående vindue	Udarb.:	M.Rabjerg
Lodret snit i overkarm/ramme 57mm	Godk.:	
Snit V 1	Filnavn:	V1s57

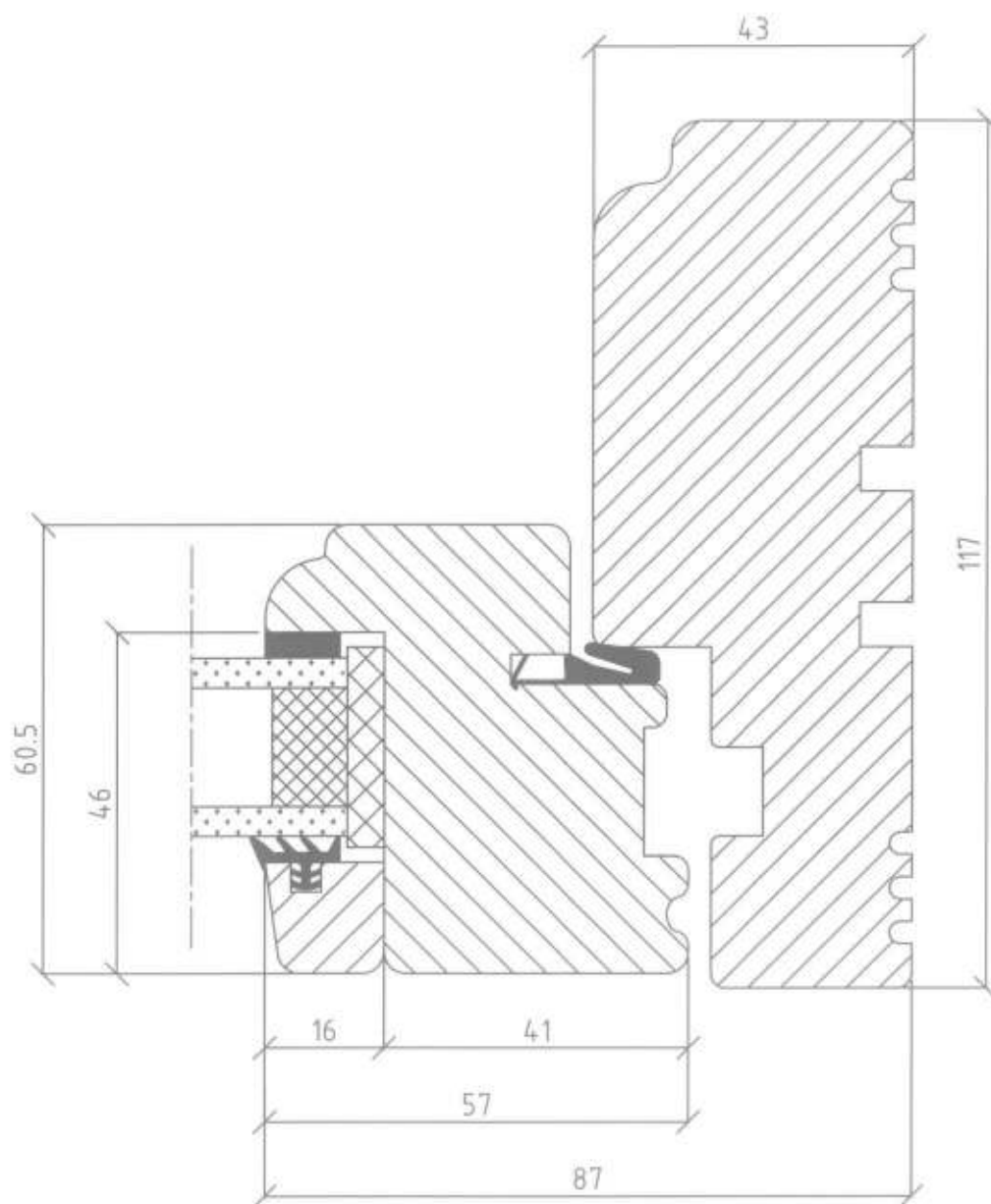

<b>TOMMERUP VINDUET A/S</b>  Ellehaven 2-9 Tommerup Tel: 63 76 61 10 Fax: 63 76 61 11 Email: info@tommerupvinduet.dk	Dato:	29-06-05
	Mål:	1:1
Udadgående vindue	Udarb.:	M.Rabjerg
Vandretsnit i sidekarm/ramme	Godk.:	
Snit V 2	Filnavn:	V2s

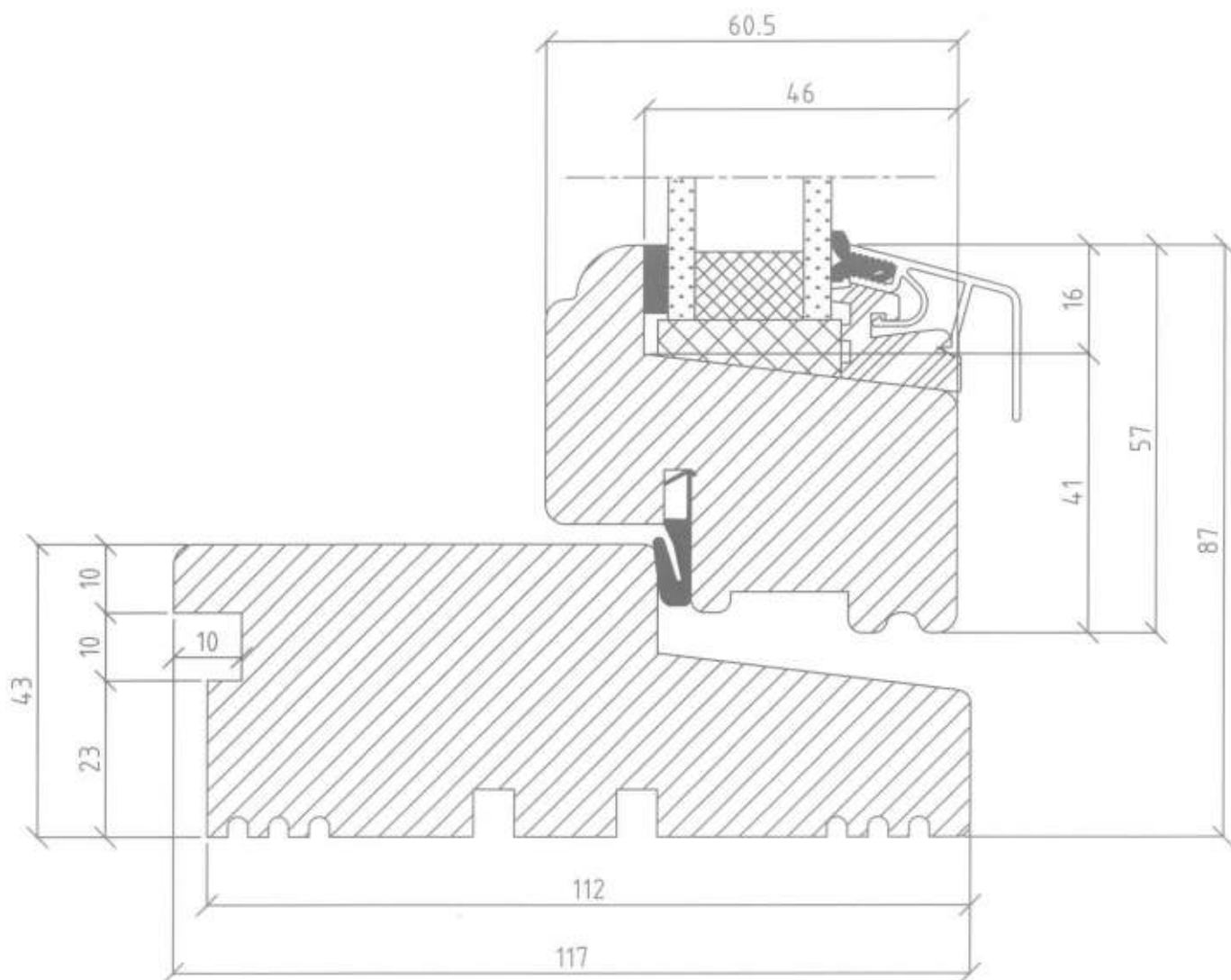

<b>TOMMERUP VINDUET</b> $\frac{A}{S}$  Ellehaven 2-9 Tommerup Tel: 63 76 61 10 Fax: 63 76 61 11 Email: info@tommerupvinduet.dk	Dato:	16-01-04
	Mål:	1:1
Udadgående vindue	Udarb.:	M.Rabjerg
Lodret snit i bundkarm/ramme	Godk.:	
Snit V 5	Filnavn:	V5s

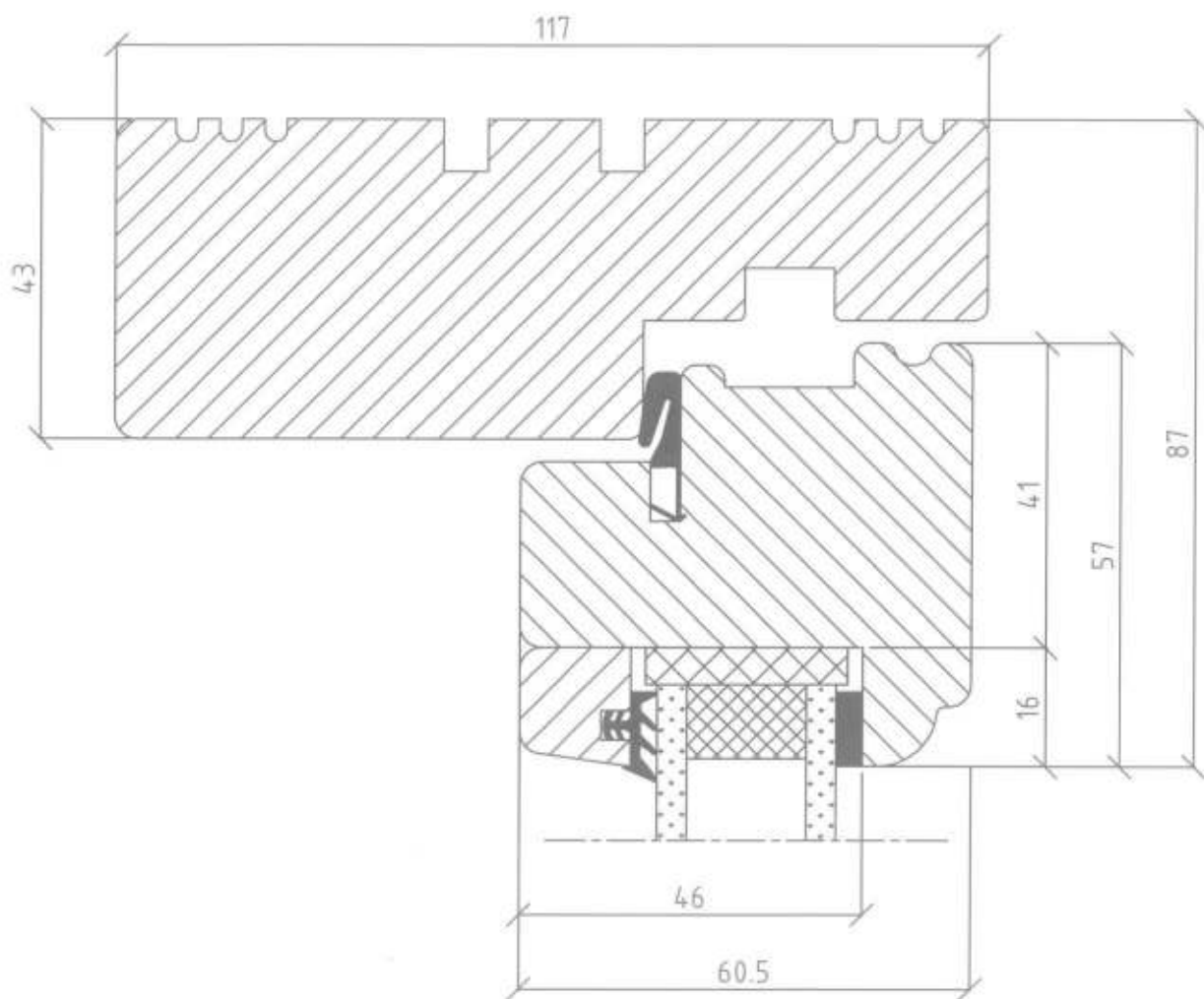

<b>TOMMERUP VINDUET A/S</b>  Ellehaven 2-9 Tommerup Tel: 63 76 61 10 Fax: 63 76 61 11 Email: info@tommerupvinduet.dk	Dato:	20-09-05
	Mål:	1:1
Indadgående vindue	Udarb.:	M.Rabjerg
Lodret snit i overkarm/ramme 57mm	Godk.:	
Snit VI 1	Filnavn:	VI1s57

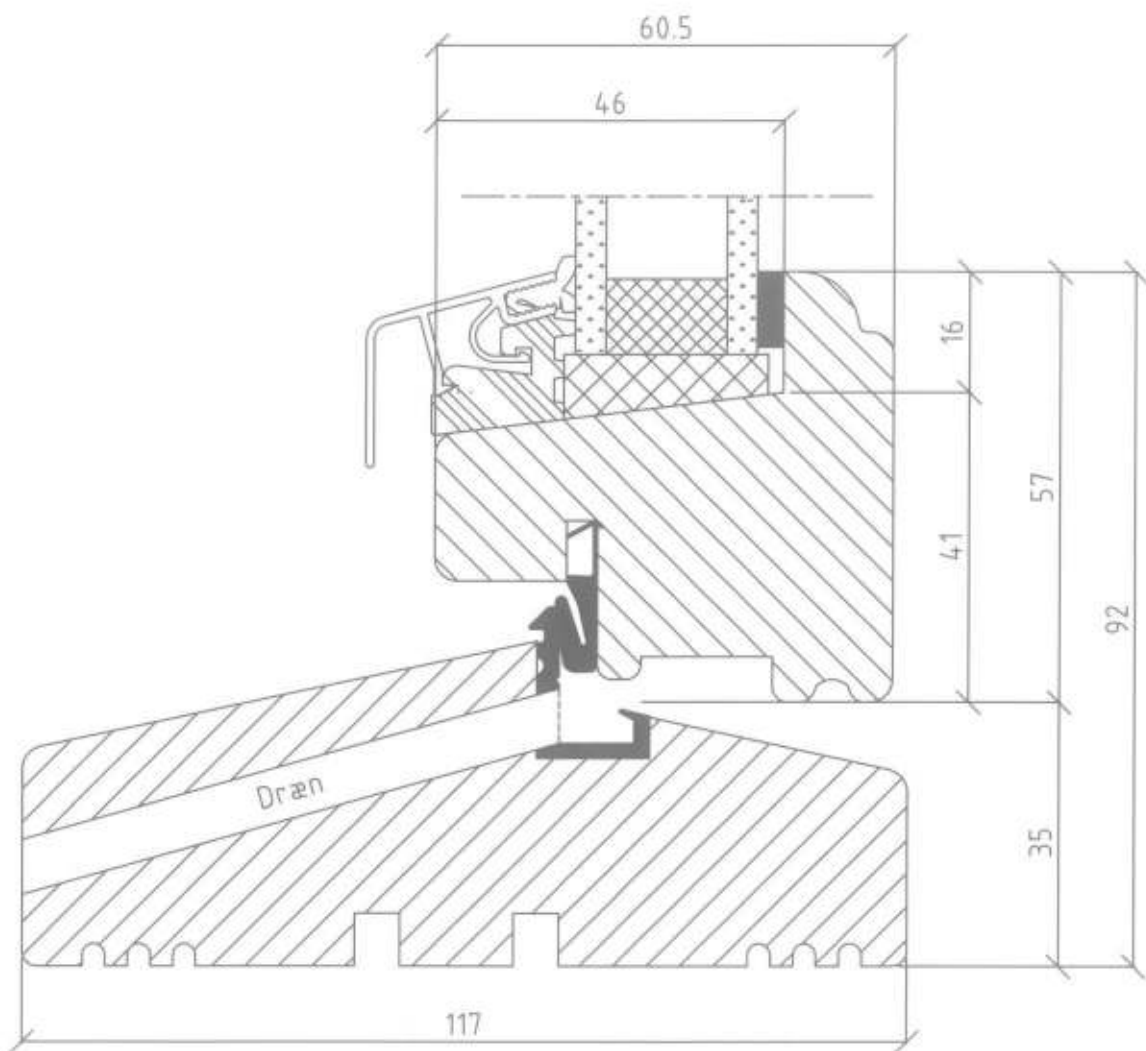

<b>TOMMERUP VINDUET A/S</b>  Ellehaven 2-9 Tommerup Tel: 63 76 61 10 Fax: 63 76 61 11 Email: info@tommerupvinduet.dk	Dato:	16/10-08
	Mål:	1:1
Indadgående vindue	Udarb.:	M.Rabjerg
Lodret snit i bundkarm/ramme Indadgående	Godk.:	
Snit V 5	Filnavn:	V5sInd



Udvendig sprosse

Indvendig rude

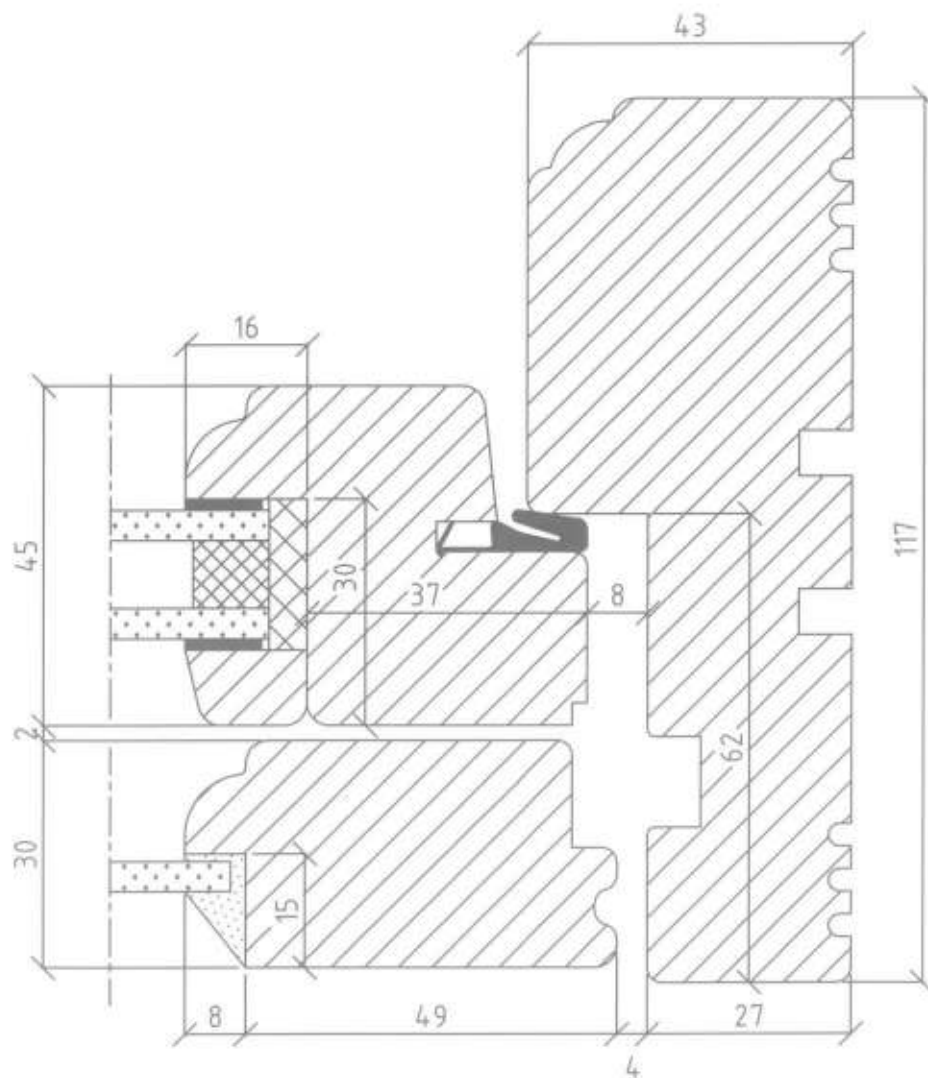
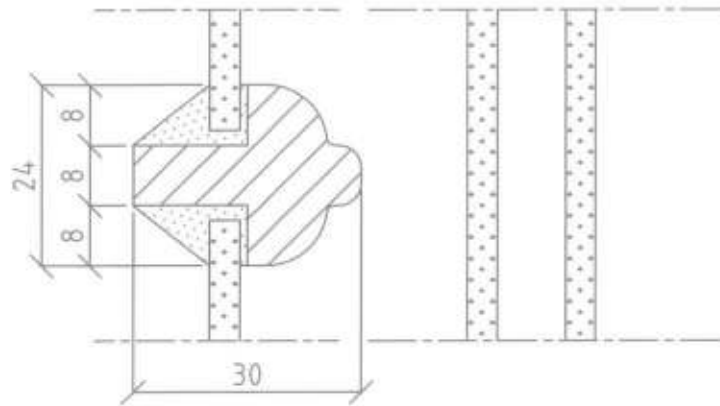

<p>TOMMERUP VINDUET <sup>A/S</sup> </p> <p>Ellehaven 2-9 Tommerup Tel: 63 76 61 10 Fax: 63 76 61 11 Email: info@tommerupvinduet.dk</p>	Dato:	05/05-09
	Mål:	1:1
Udgående koblet vindue 1 + 2	Udarb.:	M. Rabjerg
Vandretsnit i sidekarm/ramme, hængselsside	Godk.:	
Snit V 2	Filnavn:	Koblet1+2H

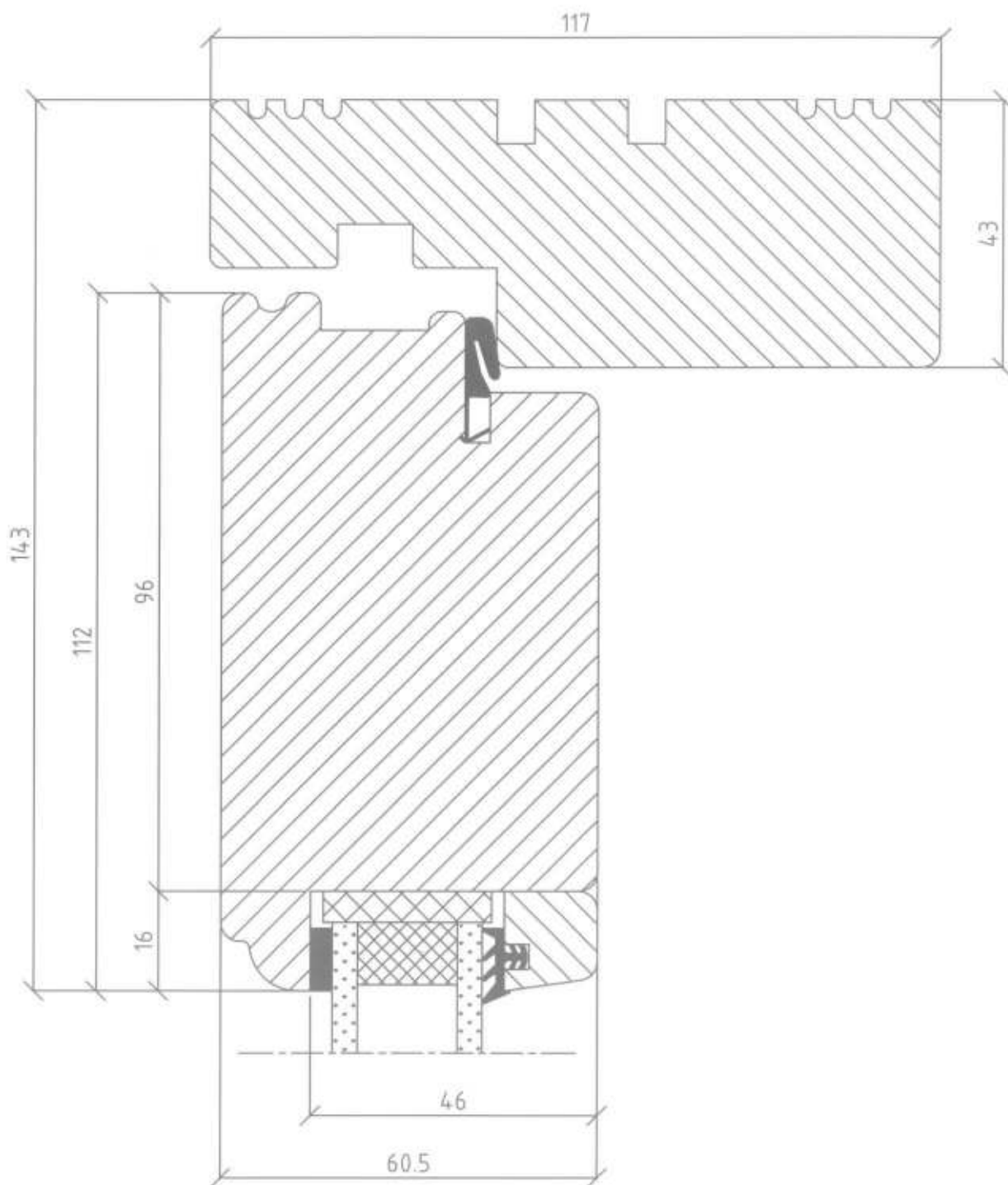

<b>TOMMERUP VINDUET A/S</b>  Ellehaven 2-9 Tommerup Tel: 63 76 61 10 Fax: 63 76 61 11 Email: info@tommerupvinduet.dk	Dato:	14-08-06
	Mål:	1:1
Indgående dør	Udarb.:	M.Rabjerg
Lodret snit i overkarm/ramme	Godk.:	
Snit 11/11A	Filnavn:	11as

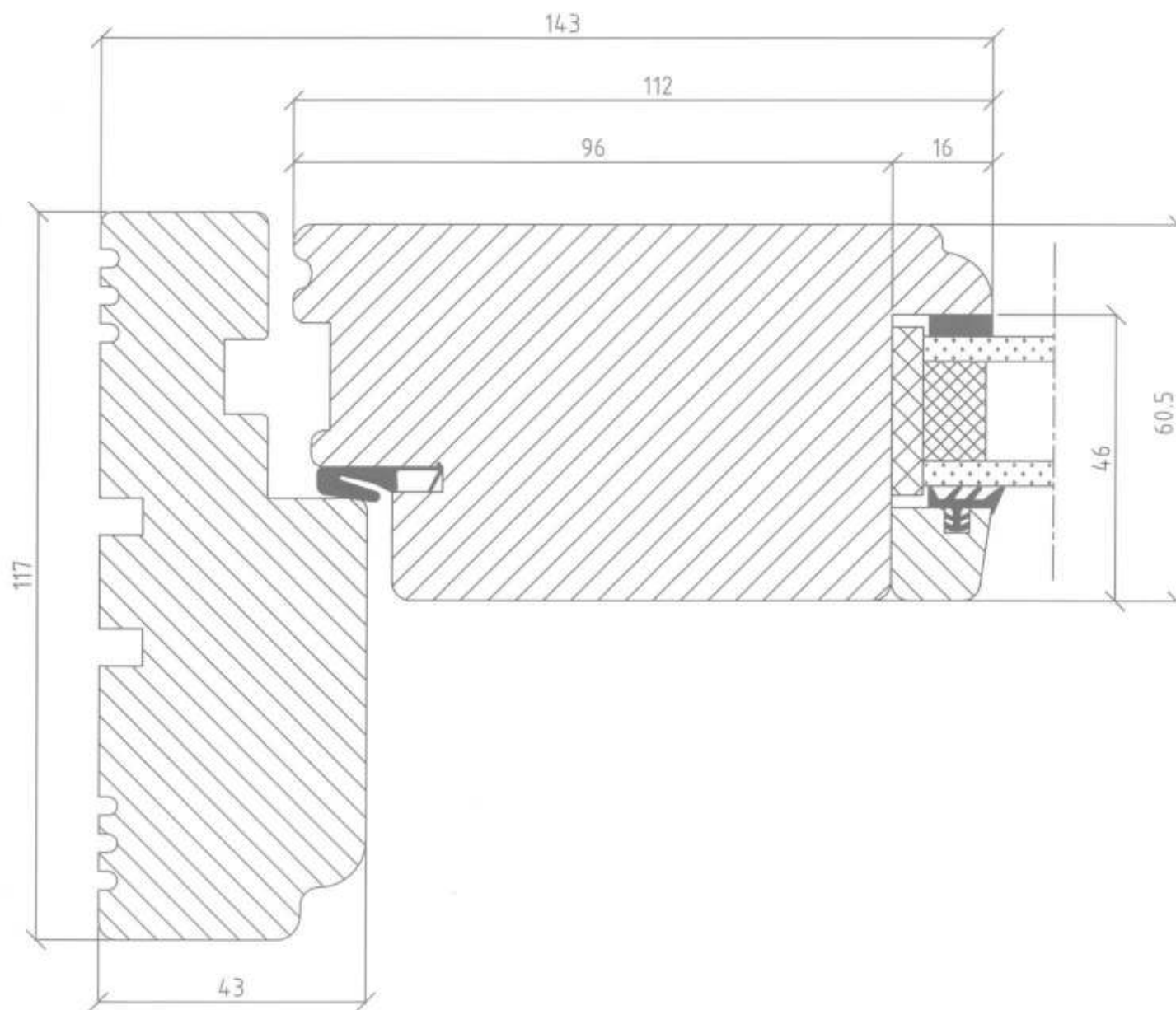

<b>TOMMERUP VINDUET A/S</b>  Ellehaven 2-9 Tommerup Tel: 63 76 61 10 Fax: 63 76 61 11 Email: info@tommerupvinduet.dk	Dato:	30/06-06
	Mål:	1:1
Indadgående dør	Udarb.:	M.Rabjerg
Lodret snit i sidekarm/ramme (hængselside)	Godk.:	
Snit 13	Filnavn:	13s

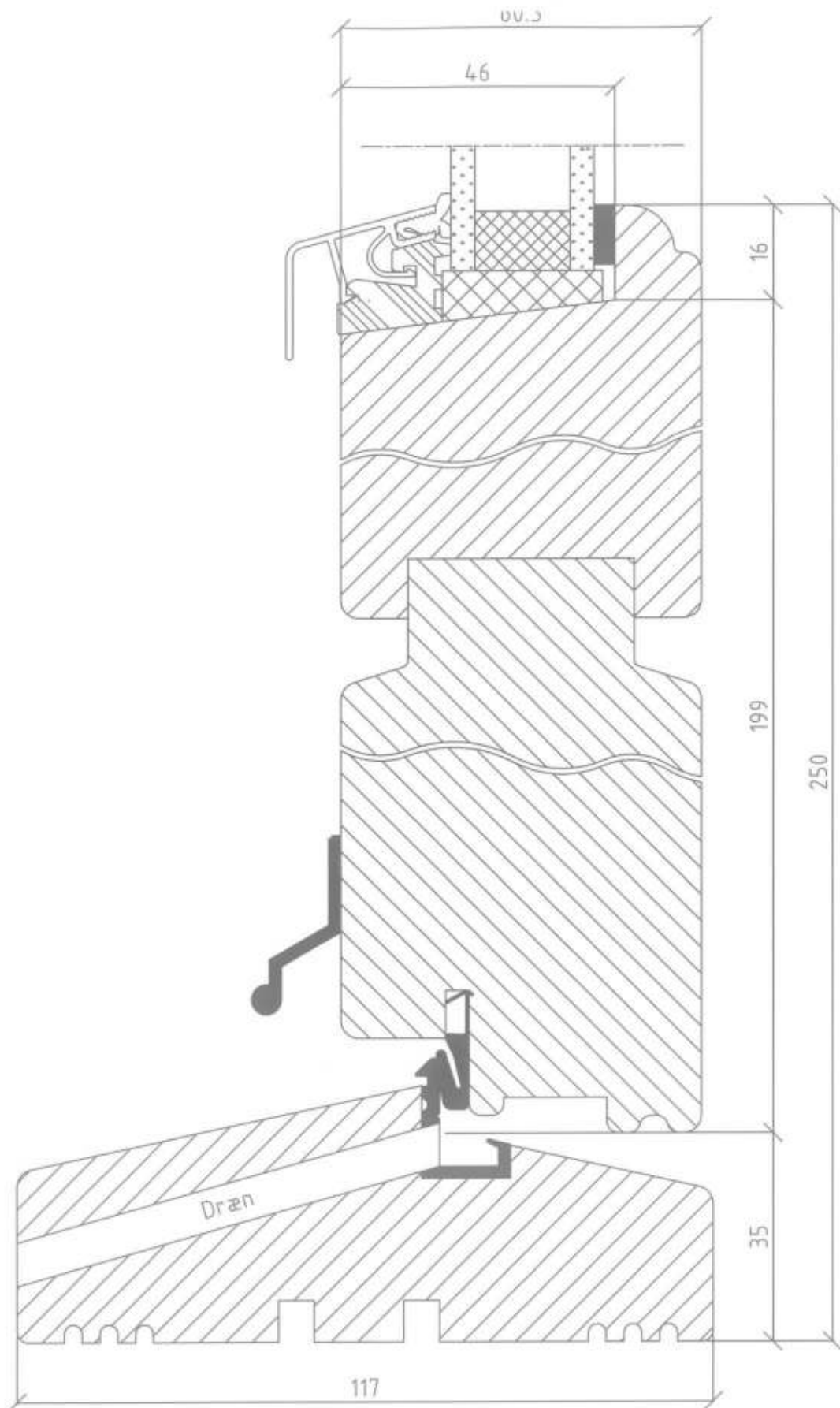

<b>TOMMERUP VINDUET A/S</b>  Ellehaven 9 DK Tonnerup Tel.: +45 64 75 19 30 Fax.: +45 64 75 19 28	Dato:	21-06/06
	Mål:	1:1
Indadværende dør	Udarb.:	M.Rabjerg
Lodret snit i bundkarm m/ alu-vandnæse	Godk.:	
Snit 15A	Filnavn:	15asA

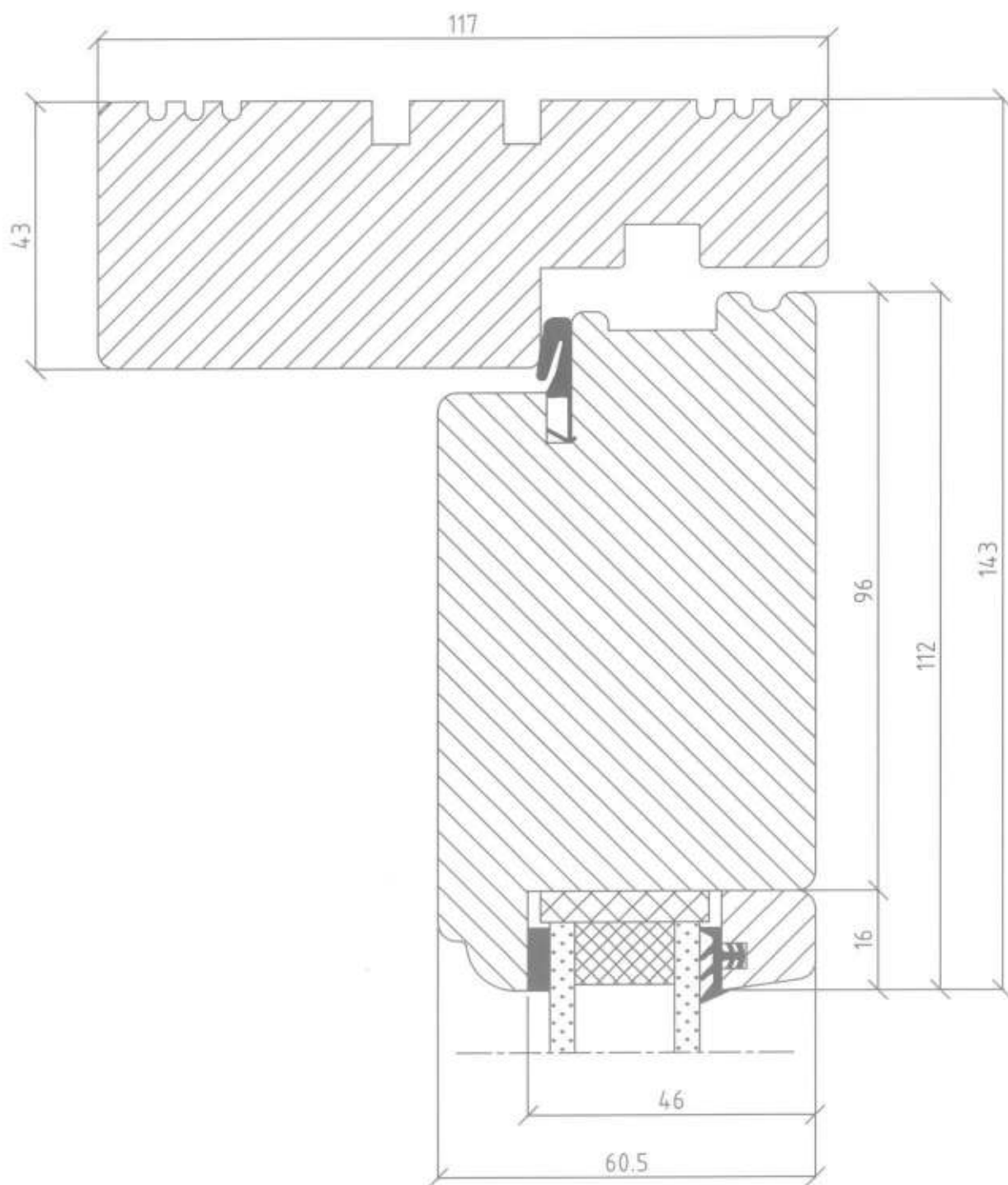

<b>TOMMERUP VINDUET</b> $\frac{A}{S}$  Ellehaven 2-9 Tommerup Tel: 63 76 61 10 Fax: 63 76 61 11 Email: info@tommerupvinduet.dk	Dato:	14-08-06
	Mål:	1:1
Udadgående dør	Udarb.:	M.Rabjerg
Lodret snit i overkarm/ramme	Godk.:	
Snit U 1/ U 1A	Filnavn:	U1as

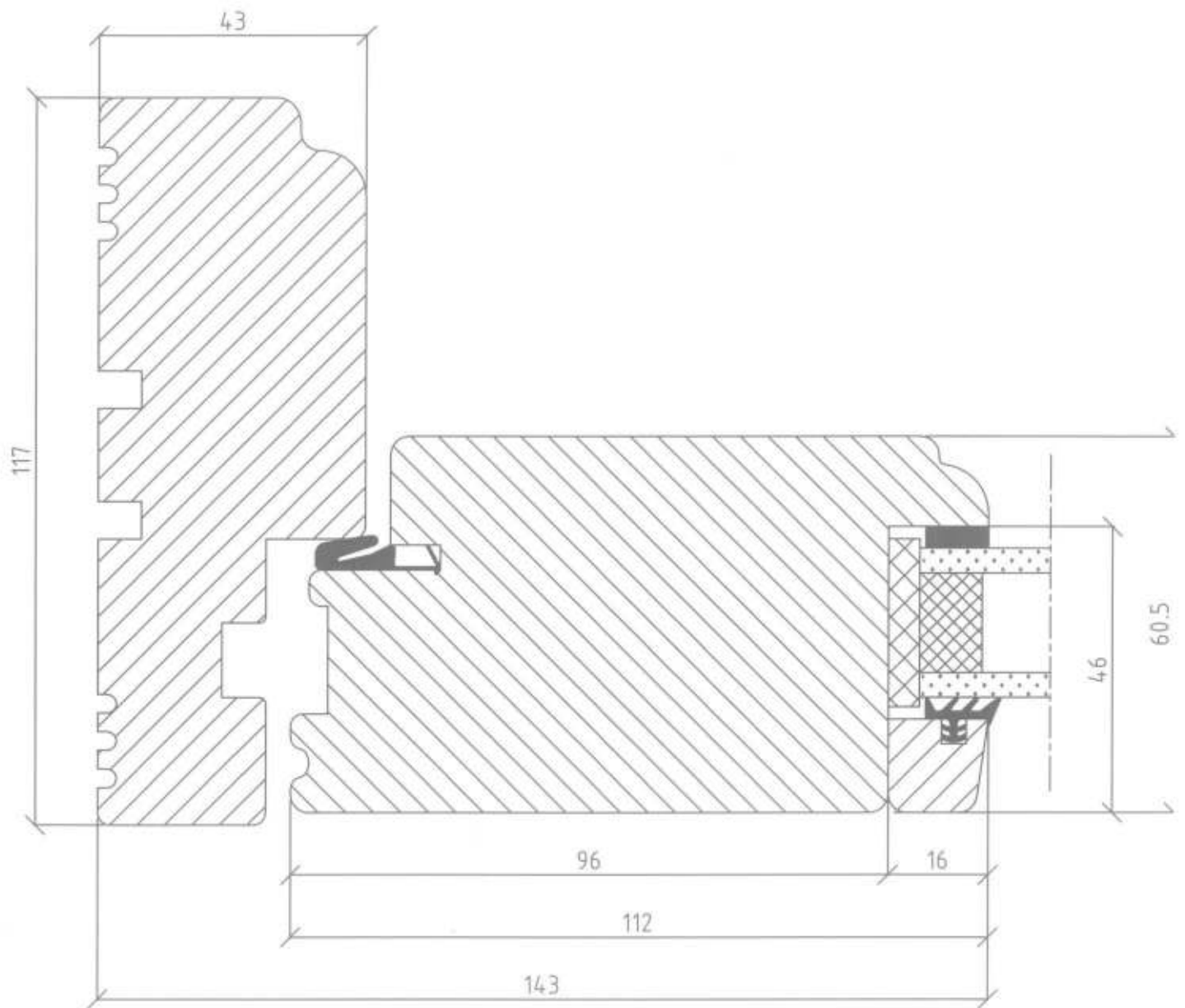

<b>TOMMERUP VINDUET A/S</b>  Ellehaven 2-9 Tommerup Tel: 63 76 61 10 Fax: 63 76 61 11 Email: info@tommerupvinduet.dk	Dato:	09-03/05
	Mål:	1:1
Udadgående dør	Udarb.:	MRA
Lodret snit i sidekarm/ramme (hængselside)	Godk.:	
Snit U 3	Filnavn:	U3s

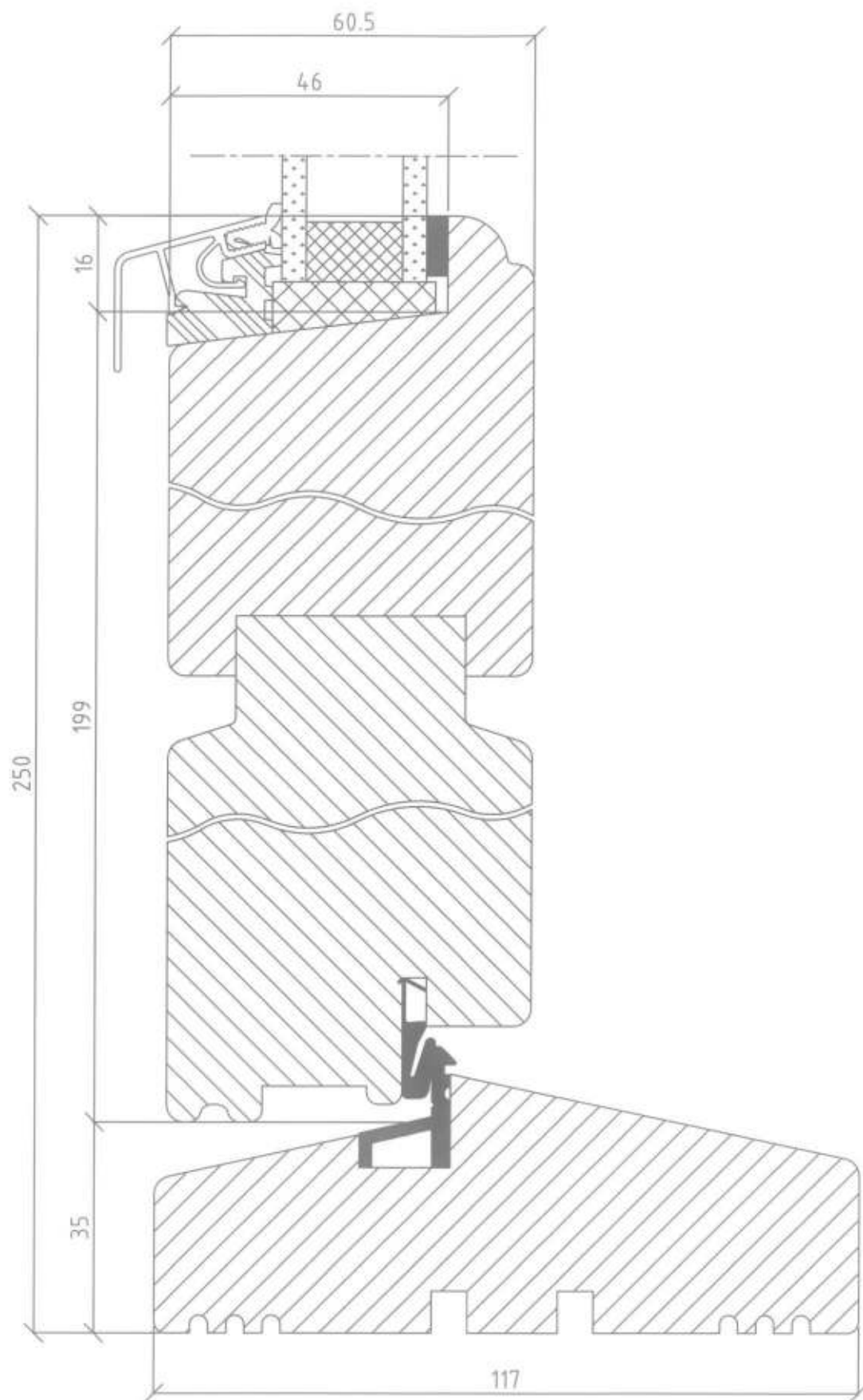

TOMMERUP VINDUET A/S 		Dato:	26-06/06
Ellehaven 9 DK Tommerup Tel.: +45 64 75 19 30 Fax.: +45 64 75 19 28		Mål:	1:1
Udadgående dør		Udarb.:	M.Rabjerg
Lodret snit i bundkarm		Godk.:	
Snit U 5A		Filnavn:	USas

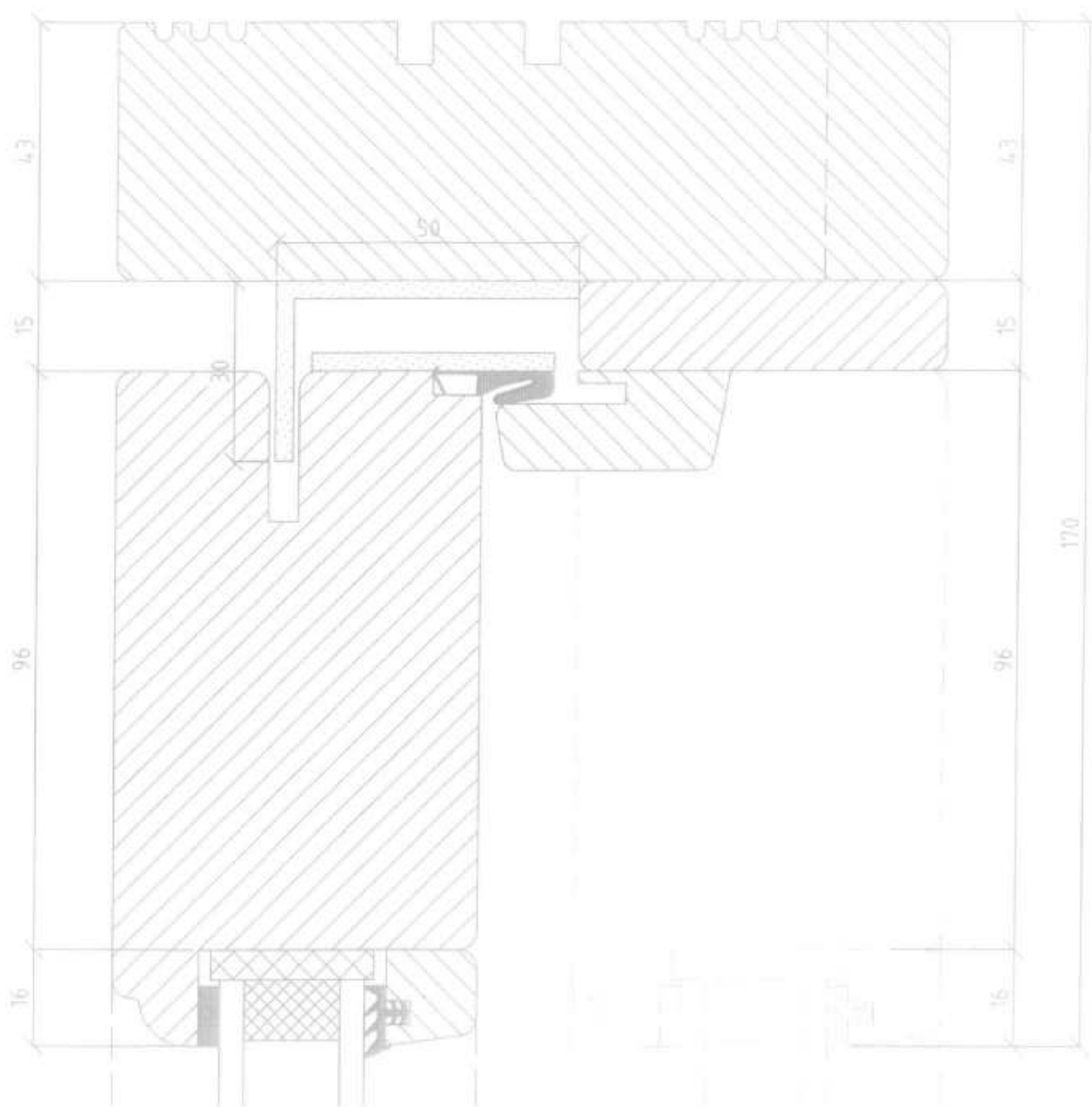

# TOMMERUP VINDUET $\frac{1}{2}$

Ellefsens 2-9 Tommerup Tel. 63 76 6110 Fax. 63 76 6111 www.tommerupvinduet.dk



Hæveskydedør

Lodret snit i overkarm/ramme

Snit HS 1

Dato: 23-09-10

Mål: 1:1

Udarb: M. Rabjerg

Godk:

Filnavn: HS1



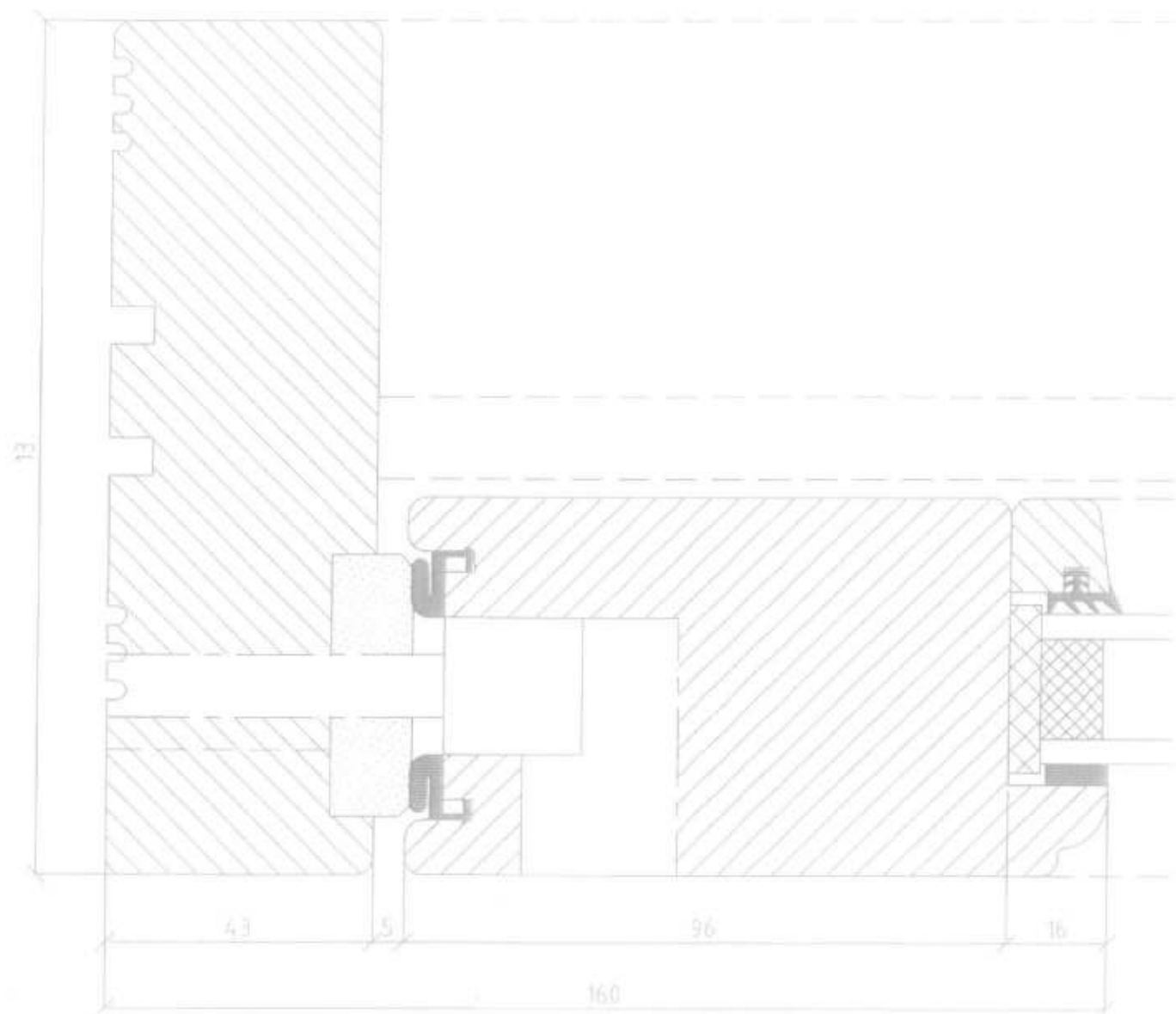

<b>TOMMERUP VINDUET</b> 		Dato	08-11-09
<small>Bleikervei 2-9 Tommerup Tel: 63 16 51 10 Fax: 63 16 51 11 - <a href="http://www.tommerupvinduet.dk">www.tommerupvinduet.dk</a></small>		Mål	1:1
Hæveskydedør		Udarb	M. Rabjerg
Vandret snit i sidekarm/ramme lukkeside		Godk	
Snit HS 2		Filnavn	HS2

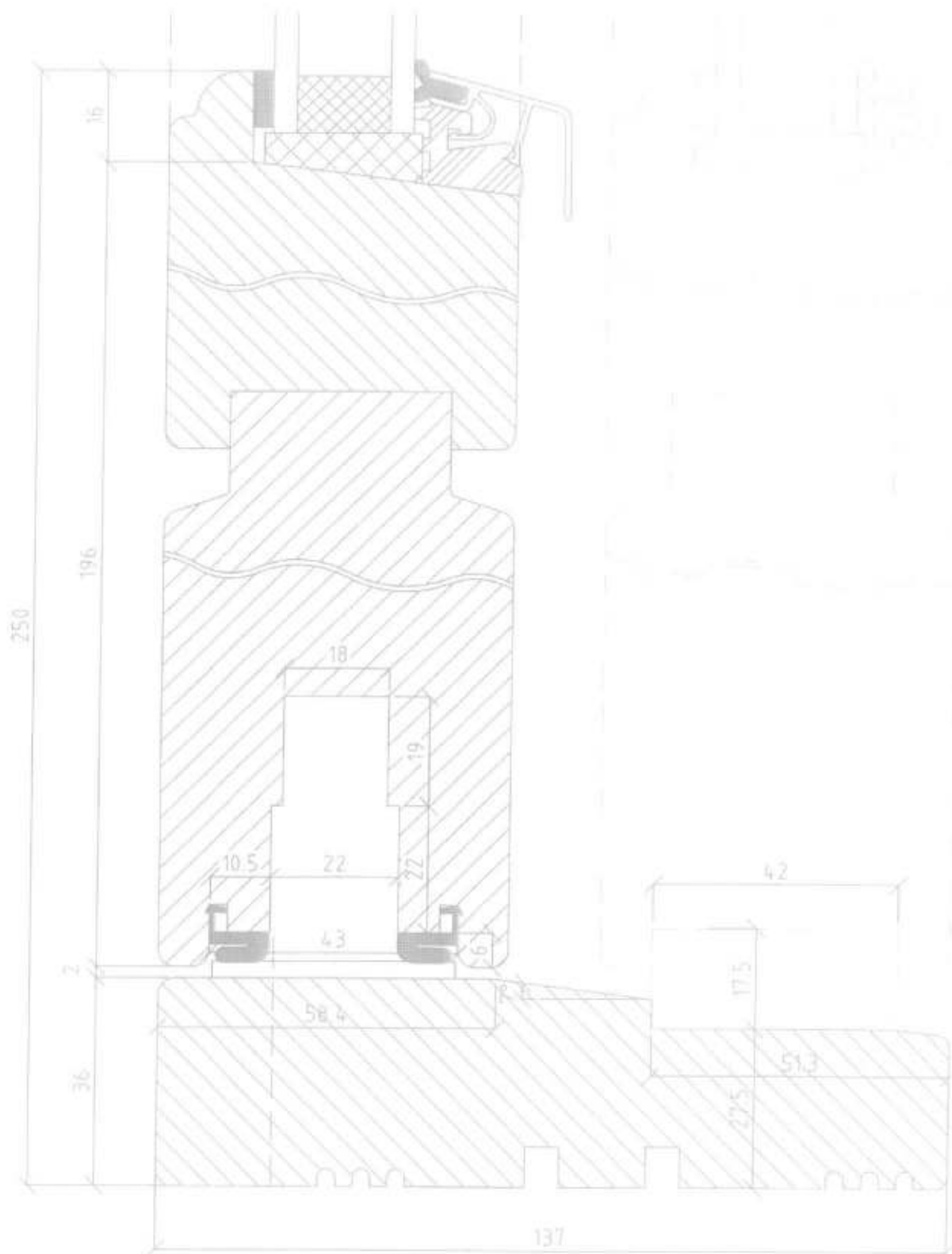

TOMMERUP VINDUET $\frac{A}{S}$ 		Date:	08-11-09
Elevløren 2-8 Tommerup Tlf. 43 76 61 18 Fax 43 76 61 11 www.tommerupvinduet.dk		Mål:	1:1
Hæveskydedør		Udarb.:	M. Rabjerg
Lodret snit i underkarm/ramme		Godk.:	
Snit HS 5		Filnavn:	HS5